

AR767 H.P. Power - Jet Cleaner

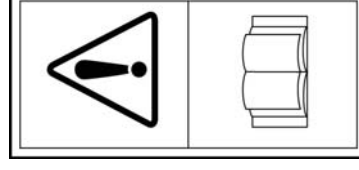

OPERATING MAINTENANCE MANUAL

Place
Stamp
Here



Warning: This manual must be read before installation or use of the unit.

**Important
Notice:**

Winter storage or long time storage. Drain all water out of the pump. Flush the pressure washer with a 50% antifreeze solution, and relieve the pressure. Flush the pressure washer before you use it again to remove the antifreeze.

A.R. North America
Attn: Pressure Washer Warranty Department
140 - 81st Avenue NE
Fridley, MN 55432

PRESSURE WASHER LIMITED WARRANTY

This product is under warranty to the original retail consumer against defects in material and workmanship for a period of 1 (one) year on machine, 90 days on gun and hose assembly, from the date of retail purchase and is not transferable. Warranty covers replacement parts. This limited one year warranty applies only to products used in consumer applications and does not apply to rental or commercial applications.

WARRANTY RETURNS

Items returned for warranty consideration must have a Returned Merchandise Authorization (RMA) number. All unauthorized returns will be refused and shipped back to sender. Call 866-235-5112 Monday through Friday 8:00 a.m. - 5:00 p.m (Central Standard Time). Or E-Mail to: info@arnorthamerica.com 24 hours a day.

A.R. North America, Inc.

140 - 81st Avenue NE • Fridley, MN 55432
Attn: Pressure Washer Warranty Department



PRESSURE WASHER LIMITED WARRANTY CARD

Mr. Mrs. Ms. Miss Initial: Last Name: Apt. #:

First Name: Address: (Number and Street) City: State: Zip/Postal code:

Telephone: Date of Purchase: Purchase Price: \$.00
Month Day Year (excluding tax)

Model Number: Serial Number:

Located on product package/box
Store Name:

All fields must be filled out for warranty.
Warranty void from Manufacture if this card is not returned.

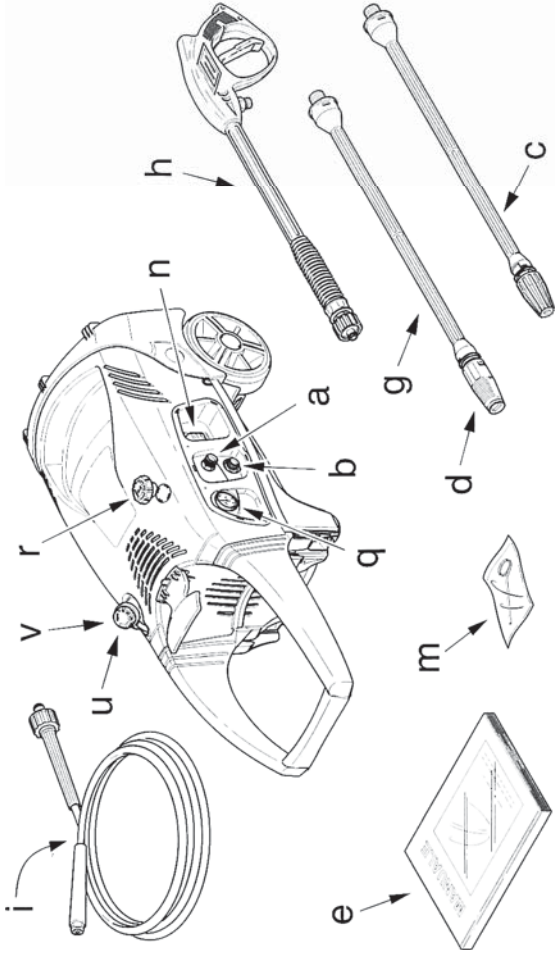

- Key
- a - Water outlet (OUTLET)
 - b - Water inlet with filter (INLET)
 - c - High pressure rotating nozzle kit (optional accessory)
 - d - Adjustable spray nozzle
 - e - Maintenance handbook
 - g - Lance
 - h - Gun with safety catch
 - i - High-pressure hose
 - m - Nozzle cleaning tool
 - n - Motor switch
 - q - Pressure gauge
 - r - Pressure regulator knob
 - u - Detergent tank plug
 - v - Detergent control knob



1. INTRODUCTION

















The high pressure power-jet cleaner you have purchased is a technologically advanced product designed by one of the leading European manufacturers of high-pressure pumps. To obtain the best performance from your unit, read this booklet carefully and follow the instructions each time you use the cleaner. We congratulate you on your choice and wish you successful operation.

















* Read and understand these instructions before operating the cleaner. Pay particular attention to the safety symbols through out this manual. Failure to comply with these instructions may result in personal injury or property damage. DO NOT allow children to operate or play on or around this equipment.

* Plug the cleaner into a properly grounded 3-prong outlet. Improper grounding can result in electrical shock.

2. SAFETY RULES

2.1 Safety "MUST NOTS"

- 2.1.1   DO NOT use the cleaner with flammable or toxic liquids, or any products, which are not compatible with the correct operation of the cleaner. **EXPLOSION OR POISONING HAZARD.**
- 2.1.2   DO NOT direct the water jet towards people or animals. **INJURY HAZARD.**
- 2.1.3   DO NOT direct the water jet towards the unit itself, electrical parts or towards other electrical equipment. **ELECTRICAL SHOCK HAZARD.**
- 2.1.4  DO NOT use the cleaner outdoors if raining. **SHORT CIRCUIT HAZARD.**
- 2.1.5  DO NOT allow children or incompetent persons to use the cleaner. **INJURY HAZARD.**
- 2.1.6   DO NOT touch the plug and/or socket with wet hands. **ELECTRIC SHOCK HAZARD.**
- 2.1.7   DO NOT use the cleaner if the electrical cable is damaged. **ELECTRIC SHOCK AND SHORT CIRCUIT HAZARD.**
- 2.1.8   DO NOT use the cleaner if the high-pressure hose or spray gun assembly is damaged. **EXPLOSION HAZARD.**
- 2.1.9  DO NOT jam or lock the spray gun trigger in the operating position. **ACCIDENT HAZARD.**
Check that the data plates are affixed to the cleaner, if not, contact your dealer. Cleaners without plates must NOT be used, as they are unidentifiable and potentially dangerous. **ACCIDENT HAZARD.**
- 2.1.10 

- 2.1.11  DO NOT tamper with or alter the calibration of the safety valve. EXPLOSION HAZARD.
- 2.1.12  DO NOT alter the original diameter of the spray head nozzle. OVER PRESSURIZATION MAY OCCURE.
- 2.1.13  DO NOT leave the cleaner unattended. ACCIDENT HAZARD.
- 2.1.14  DO NOT move the cleaner by pulling on the electrical cable. SHORT CIRCUIT HAZARD.
- 2.2 Safety "MUSTS"**
- 2.2.1  All electrical circuits MUST BE PROTECTED against the water jet. SHORT CIRCUIT HAZARD.
- 2.2.2  The cleaner MUST ONLY BE CONNECTED to a ground fault system. ELECTRIC SHOCK HAZARD.
- Use of a safety residual current circuit-breaker (R.C.C.B.) will provide additional protection for the operator. (30 mA)
- 2.2.3   The high pressure may cause materials to bounce off surfaces at speeds; therefore protective clothing and safety goggles MUST BE WORN. INJURY HAZARD.
- 2.2.4  Before working on the cleaner, REMOVE the electrical plug. ACCIDENTAL START UP HAZARD.
- 2.2.5  Before pressing the trigger, GRIP the gun firmly to counteract the recoil. INJURY HAZARD.
- 2.2.6  COMPLY WITH the requirements of the local water supply company. According to DIN 1988, power-jet cleaners may only be connected to the mains drinking water supply with a backflow preventer valve with drain facility is installed in the supply hose. CONTAMINATION HAZARD.
- 2.2.7  A qualified technician MUST carry out maintenance and/or repair of the electrical components. ACCIDENT HAZARD.
- 2.2.8  DISCHARGE residual pressure before disconnecting the cleaner hose. Turn the water supply off and squeeze the spray gun trigger. INJURY HAZARD.
- 2.2.9  Before each use. CHECK that all the screws are fully tightened and that there are no broken or worn parts.
- 2.2.10  Only USE detergents, which will not corrode the coating materials of the high- pressure hose/electrical cable and unit components. EXPLOSION AND ELECTRIC SHOCK HAZARD.
- 2.2.11  ENSURE that all people or animals keep a minimum distance of 16 yd. (15m) away. INJURY HAZARD.

Always use two hands when operating a pressure washer. This will assure complete control of the equipment.

Always test the GFCI plug prior to using the cleaner.

Never test the pressure of the cleaner against any part of the body.

Use the trigger lock whenever the spray gun is not being used for cleaning.

Always seek emergency medical care immediately if any fluid penetrates the skin. A cut may be deeper and more serious than it appears.

3. GENERAL RULES

3.1.1 The USE and MAINTENANCE manual constitutes an essential part of the cleaner equipment and should be kept in a safe place for future reference. If you sell the cleaner, the manual should be handed on to the new owner.

3.1.2 Before starting the cleaner, make sure that it is receiving water correctly. Operating the cleaner without water could damage the seals.

3.1.3 Do not disconnect the plug by pulling on the electrical cable.

3.1.4 If you are too far from the object you wish to clean, do not move the cleaner nearer by pulling on the high pressure hose; use the handle provided.

3.1.5 Protect the cleaner from freezing during the winter. Store in a warm area.

3.1.6 Do not obstruct the ventilation grilles during operation.

3.1.7 ⚠ The cross-section of any extension cord used must be proportional to their length, i.e., the longer the extension cord, the greater the cross-section; cables with a protection level of "IPX5" must be used. See table A.

Table A

Motor	Voltage Volts	Extension cable up to 25 m	Extension cable up to 50m
	220 – 230240	Section3x1.5mm ²	Section3x2.5mm ²
	100 – 115120	Section3x2.5mm ²	Section3x4mm ²

3.1.8 Position the cleaner AS NEAR AS POSSIBLE to the water supply.

3.1.9 The packaging is easily recyclable, and must be disposed of in compliance with the regulations in force in the country of installation.

PROBLEMS AND REMEDIES	CAUSES	REMEDIES
The pump does not operate at the prescribed pressure. Sudden changes in pump pressure.		
The motor buzzes but fails to start.		
Motor does not start.		
Water leakage.		
Excess noise.		
Oil leaks.		
TSS MODELS ONLY: Motor starts even though the trigger is released (when supply hose is connected).		
Power cord damage.		
Nozzle worn.	✓	Replace nozzle.
Water filter clogged.	✓	Clean filter
Water supply pressure low.	✓	Turn on the water supply tap fully.
Air being sucked into the system.	✓	Check that hose fittings are tight.
Air in pump.	✓	Switch off the cleaner and operate the gun until a steady flow of water is obtained. The switch cleaner back on.
Adjustable nozzle incorrectly positioned.	✓	Pull the spray adjuster back (+).
Water suction from external tank.	✓	Connect cleaner to the mains water supply.
Water temperature too high.	✓	Lower temperature.
Nozzle clogged.	✓	Disconnect power supply, discharge pressure and clean with tool provided.
Worn seals.	✓	Have seals replaced by an authorized service center.
No electrical power. (S)	✓	Check that the plug is firmly in the socket and that main power is present.
Supply voltage below required minimum.	✓	Check the voltage of the main supply line.
Voltage loss due to use of extension cord of inadequate cross-section or excessive length.	✓	Consult instructions regarding extension cords.
High pressure cleaner in disuse for long time.	✓	Contact nearest service center.
Problems with TSS device.	✓	Contact nearest service center.
High pressure system or pump hydraulic circuit not watertight.	✓	Contact nearest service center.
	✓	Contact nearest service center.

(S) If the motor stops and fails to restart, wait 2 - 3 minutes before restarting. THERMAL CUTOFF TRIPPED. If this fault occurs more than once, contact your service center.

More troubleshooting information on our website at www.arnorthamerica.com.

3.1.10

Use the cleaner only with accessories and replacement parts authorized by the manufacturer. The use of original accessories and replacement parts will ensure safe, trouble-free operation.

3.1.11

The cleaner must be used standing on a secure, stable surface, positioned as shown.



3.2 Intended Use

3.2.1 The cleaner is intended only for the cleaning of vehicles, machines, boats, buildings, etc., by the removal of stubborn dirt using clean water and chemical detergents.

For domestic use only (single-phase motors only). Not for professional use (for three-phase or industrial motors only), and only for operation at temperatures above 32° F. Compliant with EN 60335-2-79/A1 standard.

3.2.2 When using chemical detergents, only use biodegradable types. We recommend HOBBY – FOAM detergent (#3206).

3.2.3 Only clean vehicle engines in areas in which suitable oil traps are installed.

3.3 Safety Valve

3.3.1

The safety valve also functions as a pressure-limiting valve. When the gun trigger is released, the safety valve opens and the water recirculates through the pump inlet. Never try to adjust this valve.

4. INSTALLATION/ASSEMBLY

4.1

Fit the lance into the gun by rotating and pushing until the two parts are completely locked.



4.2 Connect the gun to the high-pressure hose.



AR767 - Motor

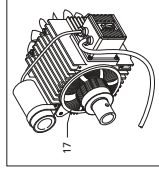
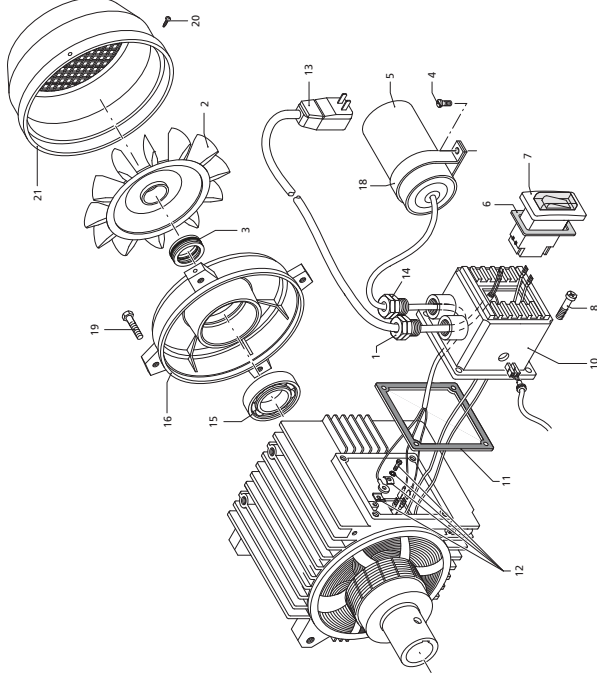

Pos.	Code	Description	Qty.
1	1271950	Cable retainer	1
2	1260300	Fab	1
3	1260970	Seal ring	1
4	1260810	Screw TCTC M4x10	1
5	2360420	Capacitor 80uF	1
6	1265080	Gasket	1
7	1272030	Switch	1
8	1261560	Screw 3,9x16	4
10	1260341	Switch box	1
11	1260400	Gasket	1
12	1269100	Earth clamp	1
13	1466890	Cable	1
14	1269090	Cable retainer	1
15	1260950	Bearing	1
16	1260961	Motor shield	1
17	44075	Electric motor	1
18	1340280	Clamp	1
19	480621	Screw TE M5x25	4
20	1261570	Screw 3,9x9,5	4
21	1271660	Fan housing	1

AR767 - Unloader

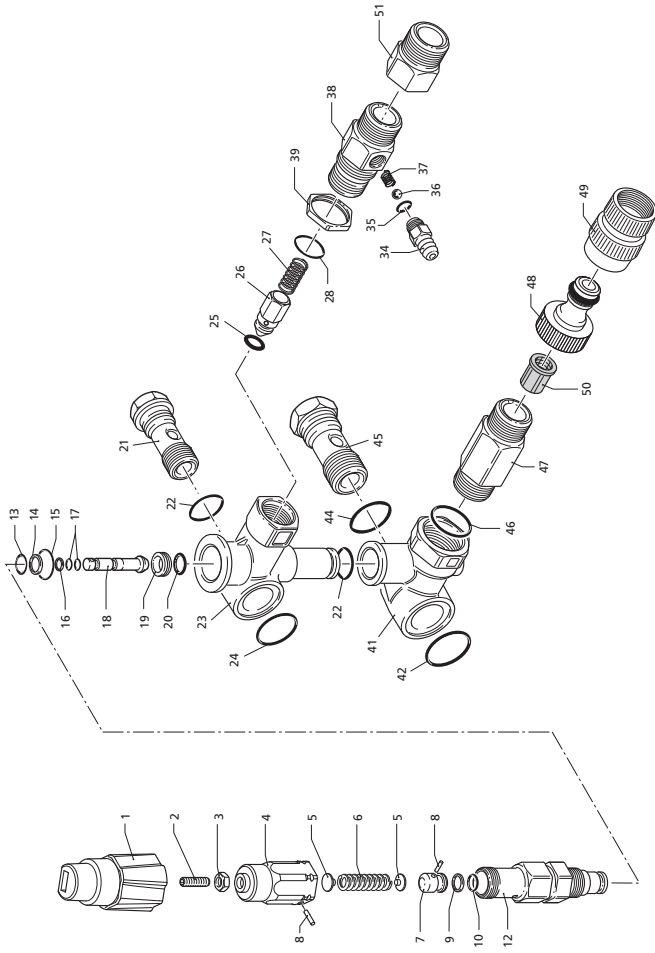

4.3 Connect the high-pressure hose to the water (OUTLET) on the cleaner.

4.4 Connect the water supply hose. (not supplied) to the water (INLET) of the cleaner. The supply hose must have an internal diameter of at least 13 mm (1/2 in.) and must be reinforced. The water supply must be at least equal to the cleaner delivery capacity.



The intake water temperature must NOT exceed 60° C (122°F). The water supply pressure must NOT exceed 10 BAR (145 PSI).

4.4.1 **CAUTION!** The cleaner must only be used with clean water; use of unfiltered water or corrosive chemicals will damage the cleaner.

4.5 Turn the motor switch to the "0" position.



4.6 Check that the electrical supply voltage and frequency (Volts/Hz) correspond those specified on the cleaner data plate. If the power supply is correct, you may now plug in the cleaner.

The cleaner must only be connected to power sockets with regulation earth connection. A differential safety breaker (30mA) will increase the safety of operators.



CAUTION! The machine may cause electrical disturbances when starting.

4.6.1 If the motor stops and fails to restart, wait 2 to 3 minutes before restarting. **THERMAL CUTOFF TRIPPED AND MUST COOL BEFORE RESTARTING.**

5. USE

5.1 Turn on the water supply tap FULLY.
5.2 Release the safety catch, then press the trigger for a few seconds to allow air to escape and to discharge residual pressure in the pipes.



Pos.	Code	Description	Qty.	Pos.	Code	Description	Qty.
1	2500210	Knob extension	1	42	1540630	O-Ring Ø23.4x2.62	1
2	392840	Grub screw M6x16	1	44	880270	O-Ring Ø17.1x1.78	1
3	1980300	Nut M6	1	45	1540260	Screw 1/2" G	1
4	2500400	Knob insert	1	46	480440	O-Ring Ø17.13x2.62	1
5	1980220	Spring plate	2	47	1560600	Suction fitting	1
6	1271070	Spring	1	48	1461470	Attachment for cap & gasket 3/4" GIP	1
7	1080041	Upper piston	1	49	40126	Suction fitting GHT	1
8	1080070	Pin	2	50	1340260	Water suction filter	1
9	1080401	Back-up ring	1	51	1343160	Fitting 1/8" G	1
10	1080250	O-Ring Ø7.6x1.78	1				
11	1980210	Piston guide	1				
12	740290	O-Ring Ø14x1.78	1				
13	800560	O-Ring Ø8.73x1.78	1				
14	880830	O-Ring Ø15.54x2.62	1				
15	1271170	Back-up ring	1				
16	1080190	O-Ring Ø2.90x1.78	2				
17	1271160	Lower piston	1				
18	1980200	Valve seat	1				
19	1470210	O-Ring Ø9x1	1				
20	1540270	Screw 3/8" G - Brass	2				
21	390080	O-Ring Ø11.91x2.62	2				
22	1540510	Valve housing	1				
23	1140450	O-Ring Ø20.24x2.62	1				
24	1460430	O-Ring Ø4x2.5	1				
25	1540170	Jet	1				
26	1080091	Ball spring	1				
27	394280	O-Ring Ø12.42x1.78	1				
28	1560490	Hose tail	1				
34	480480	O-Ring Ø4.48x1.78	1				
35	1250280	Stainless steel ball	1				
36	1560520	Spring	1				
37	1540570	Fitting 3/8" G Ø2	1				
38	1540300	Nut	1				
39	1540280	By-pass housing 3/8" G	1				

Repair Kits

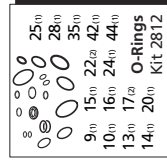

AR767 - Pump

5.3 Keeping the trigger pressed, push the switch to start the motor.
Turn the pressure control knob to the desired setting. (For models with this feature).

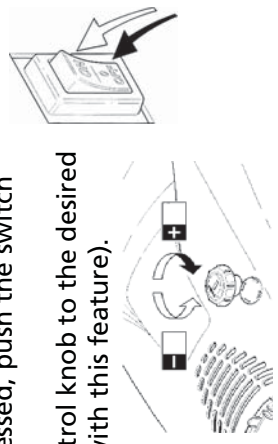

5.3.1 When re-starting the motor, always keep the spray gun trigger compressed.

5.4 Using Detergent

5.4.2 **CAUTION!** liquid detergent must be sprayed at low pressure. See 5.5 "Proper use of standard accessories".

5.4.2 Fill the detergent tank to the level indicated through the inlet.

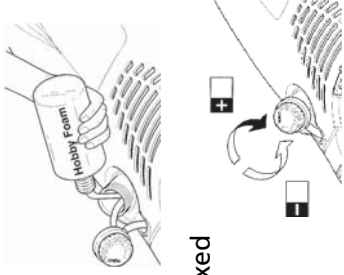

5.4.3 Select LOW PRESSURE (see instructions); the detergent will be sucked up and mixed with the water, with the suction rate regulated by the knob provided.

5.4.4 Now distribute the detergent drawn in and mixed with water.

5.5 Correct Use of standard accessories.

5.5.1 The cleaner is equipped with the adjustable nozzle, which provides some important functions:

5.5.2 LOW PRESSURE operation (for suction and spraying of detergent).

5.5.3. HIGH PRESSURE operation (for high pressure washing and rinsing).

5.5.4 Jet adjustment from pencil to fan. (For models with this feature).

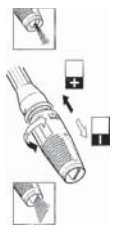

5.6 Correct Use of the Rotary Nozzle (Where fitted)

5.6.1 For increased washing power, use the rotary nozzle kit as follows:

5.6.2 Turn off the high pressure cleaner.

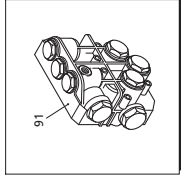
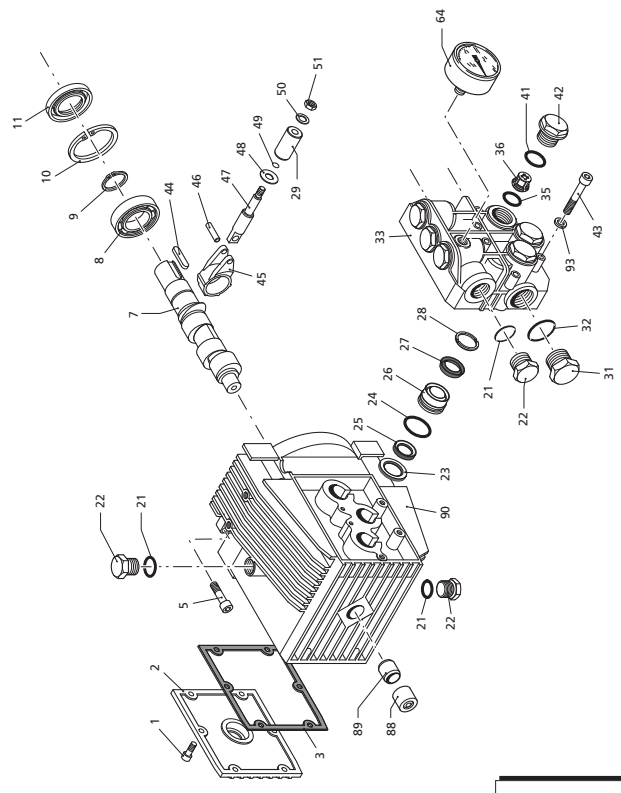

Pos.	Code	Description	Qty.
1	1260760	Screw TCEI M5x20	6
2	1269101	Rear cover	1
3	1260040	Gasket	1
5	1260780	Screw TCEI M5x25	4
7	1260190	Crankshaft	1
8	1804000	Bearing	1
9	1260770	Circlip Øe25	1
10	1260790	Circlip Ø152	1
11	1260750	Seal ring	1
21	7402900	O-Ring Ø14x1.78	3
22	1980740	Plug 3/8" G - Brass	3
23	1260460	Seal ring	3
24	1260420	O-Ring Ø26.70x1.78	3
25	1260440	C1 gasket	3
26	1260151	Piston guide Ø15	3
27	1271650	Gasket Ø15	3
28	1260141	Gasket support ring	3
29	1260121	Piston Ø15	3
31	820361	Plug 1/2" G - Brass	1
32	180101	O-Ring Ø17.5x2	1
33	1260021	Pump head	1
35	880830	O-Ring Ø15.54x2.62	6
36	1269050	Complete valve	6
41	960160	O-Ring Ø17.86x2.62	6
42	1260162	Valve plug	6
43	680570	Screw TCEI M6x60	6
44	1380520	Key	1
45	1260060	Aluminum con rod	3
46	1260080	Piston pin	3
47	1260070	Guiding piston	3
48	1260091	Spacer disc	3
49	480480	O-Ring Ø4.48x1.78	3
50	1260100	Piston washer	3
51	1260110	Stainless steel nut M8	3

Repair Kits

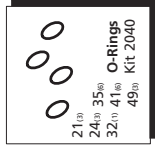
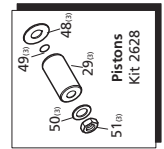
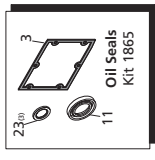

Pos.	Code	Description	Qty.
64	3226	Pressure gauge Ø40mm	1
88	1264010	Bearing	1
89	1264000	Internal ring	1
90	1260011	Pump housing	1
91	1269278	Pump head assembly	1
93	1381550	Washer Ø16.4	6

AR767 - Body

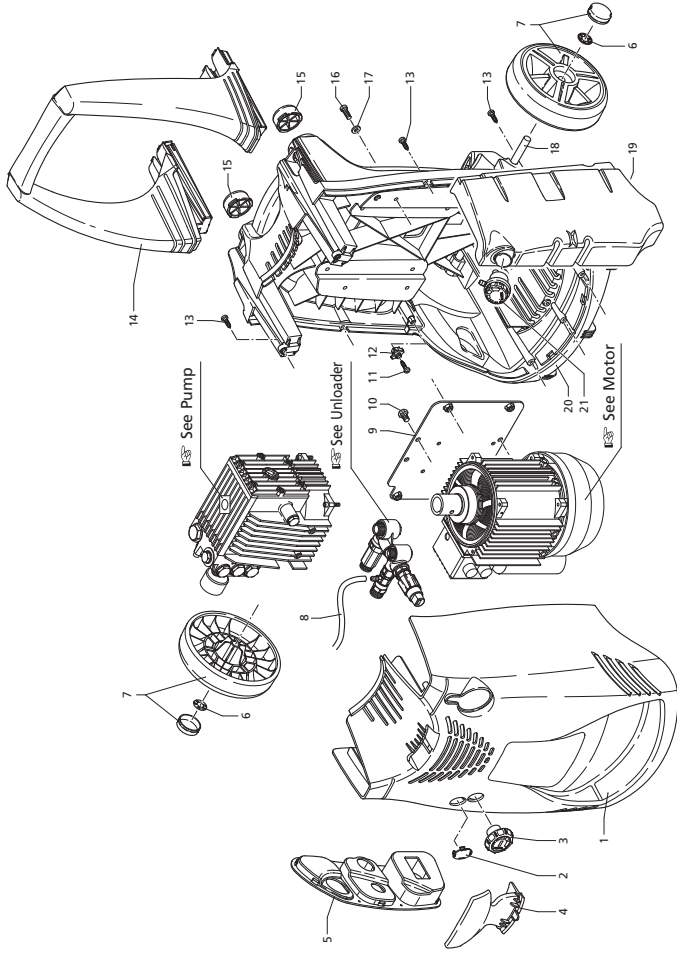

Pos.	Code	Description	Qty.
1	2500040	Blue casing	1
2	2500340	Closing plug	1
3	2500310	Knob	1
4	2500050	Hook	1
5	2500240	Cover	1
6	1680880	Washer	2
7	2500320	Driven gear Ø175	2
8	2500330	Detergent hose	1
9	2500100	Fixing plate	1
10	1260470	Screw TE M8x10	4
11	2100300	Screw 5x16	1
12	2600100	Gland	1
13	2100300	Screw 5x16	7
14	2500020	Handle	1
15	2500130	Rubber feet	2
16	880280	Screw TCEI M6x18	4
17	2180300	Washer Ø6.2	4
18	2500120	Wheels axle	1
19	2509001	Detergent tank assembly	1
20	2500010	Body	1
21	42113	Complete detergent plug	1

- 5.6.3 Unscrew the adjustable head and fit the rotary nozzle onto the lance.
- 5.6.4 Turn the high pressure cleaner back on.



5.7 Recommended Cleaning Procedure

- 5.7.1 Dissolve dirt by applying detergent with the fan jet to the dry surface.
On vertical surfaces, work from the bottom upwards. Leave the detergent to act for 1 to 2 minutes, but do not allow to dry out. Apply the high pressure jet, keeping the nozzle at least 10 in. from the surface, working from the bottom upwards. Avoid allowing the rinsing water to run on the unwashed surfaces.

5.8 Storage

- 5.8.1 Switch off the cleaner.
- 5.8.2 Turn off the water supply tap.
- 5.8.3 After use, the detergent residues should be removed from the tank.
- 5.8.4 Discharge residual pressure by pressing the trigger until no more water comes out of the adjustable nozzle.
- 5.8.5 Engage the gun safety catch.
- 5.8.6 Remove the plug from the socket.
- 5.8.7 Operate the cleaner with non-corrosive/non-toxic antifreeze before storing for the winter.

6 MAINTENANCE

- 6.1 **CAUTION!** Before working on the cleaner, disconnect the plug from the power supply socket.
To ensure good performance, check and clean the suction and detergent filters after every 50 hours of operation.
- 6.2 **!** Long periods of disuse may lead to the formation of lime scale deposits. Working through the hole on the rear, or a 6 Allen key (6) for models with this feature.
Clean the nozzle with the tool provided. Remove the lance from the gun, remove any dirt from the nozzle hole and rinse.
- 6.3 
- 6.4 

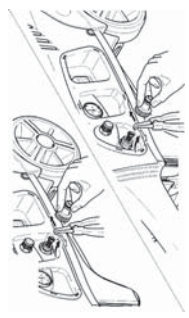

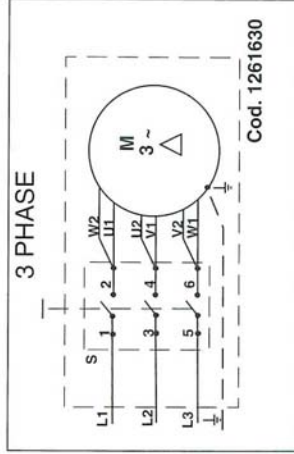
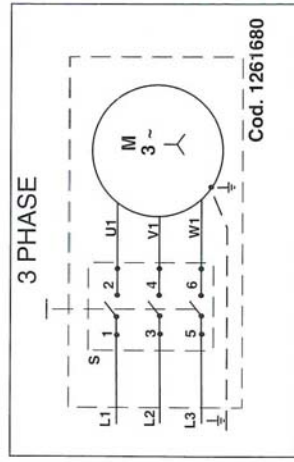
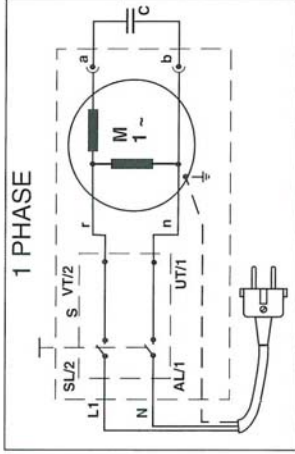
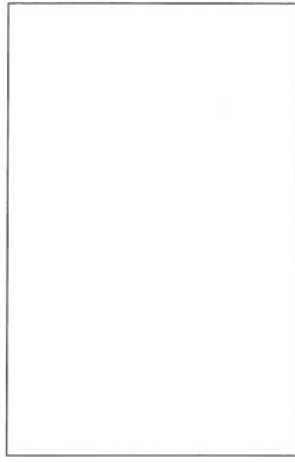
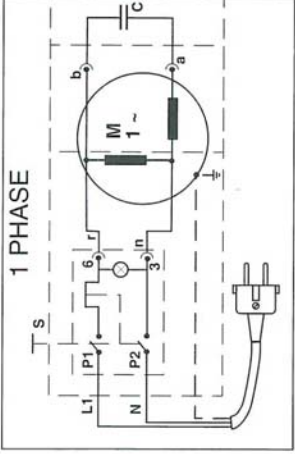
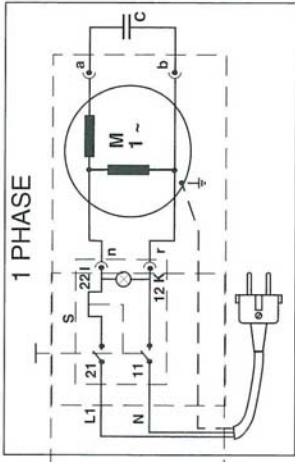

The characteristics and descriptions given are not binding. - Les données, les descriptions et les illustrations de cette notice n'engagent pas le fabricant. - Angaben, Beschreibungen, und Illustrationen sind nicht verbindlich. - Dati, descrizioni ed illustrazioni sono forniti a titolo indicativo e non impegnativo. - Los datos, las descripciones y las ilustraciones se suministran a título indicativo y no comprometen al fabricante. - As características e ilustrações não vinculam o fabricante. - Gegevens, beschrijvingen en illustraties dienen ter oriëntatie en zijn niet bindend. - Alle de leverde data, beschrijvingen en tekeningen er kun veeledende. - Informationer och bilder utan förbindelse. - Tiedot ja kuvat sitoumuksetta. - Τα στοιχεία, οι περιγραφές και οι εικόνες είναι ενδεικτικές και όχι δεσμευτικές.

n	b	a	r
BLACK	WHITE	BLUE	RED
NOIR	BLANC	BLEU	ROUGE
SCHWARZ	WEISS	BLAU	ROT
NERO	BIANCO	AZZURRO	ROSSO
NEGRO	BLANCO	AZUL	ROJO
PRETO	BRANCO	AZUL	VERMELHO
ZWART	WIT	BLAUW	ROOD
SORT	HVID	BLÅ	RØD
SVART	VIT	BLÅ	RÖD
MUSTA	VALKOINEN	SININEN	PUNAINEN
MAYPO	ΛΕΥΚΟ	ΓΑΛΑΖΙΟ	KOKKINO

